



AMIABLE

MANUFACTURERS OF EXOTHERMIC WELD POWDER & GRAPHITE MOULDS



ISO 9001:2008



CPRI, Bangalore



About Us !

Our company is a Manufacturer of Exothermic Weld Powder and Graphite Mould having more than 15 years' experience.

Our Firm is also well established organization in India, Dubai and overseas market and Manufactures and Export the following products:

- 01) Exothermic Weld Powder & Graphite Moulds (Factory situated in Gujrat – India.)
- 02) Copper Braided & Laminated Connectors (Factory situated in Mumbai - India)
- 03) Brass Parts Components, Accessories and Fittings (Factory situated in Gujrat – India.)

We have earned good reputation amongst our international customers with our Quality Assurance, On time delivery and High Customer Satisfaction. To ensure consistent product quality, we work within a quality system that is approved with **ISO 9001 – 2008, ISO 14000 and ISO 18000 certification**. We manufacture all Products with **CE & ROHS Compliance**. Strict quality checks are carried out at different stages of manufacturing and only that material which passes stringent norms finds its way in the market around the Globe. We are also awarded **GMP** (Goods Manufacturing Practise) which assures that the products which we manufacture are of high quality and do not pose risk to our customer.

Our vision

The four pillars of our vision set out the long term direction for the company where we want to go and how we are going to get there:

- We work to create a better future every day.
- We help our customers feel good, have good and get more out of life with our brands and services that are good for them and good for others.
- Whilst the company has ambitious plans for the future for its product range and its manufacturing abilities, our greatest objective will always be to maintain the highest level of quality assurance & service to the customer.
- We will develop new ways of doing business with the aim of doubling the size of our company while reducing our environmental impact.

We always believe in the power of our brands to improve the quality of people's lives and in doing the right thing.

Some of our Esteemed Customers



The secret of our success is sincerity and the passion towards everyone we work with, the communities we touch, and the environment on which we have an impact.

S. no.	EXOTHERMIC WELDING INDEX	Page no.
01	What is Exothermic Welding	04
02	General Safety Instructions	05
03	Tools Required for Exothermic Weld Process	06
04	Exothermic Weld Operation Process	08
05	Mould Selection Chart	10
06	Cable to Cable Connections (CC)	10
07	Cable to Ground Rod Connections (CR)	11
08	Cable to Bar (Cu Tape / Strip) or Cable Lug Connection (CB)	12
09	Bar to Bar / Copper Tape to Tape (BB)	13
10	Re Bar Connections (CRE)	13
11	Ground Rod to Tape / Bar Connections (BR)	14
12	Ground Rod to Ground Rod Connections (RR)	14
13	Cable to Surface (Steel/Copper) Connections (CS)	15
14	Bar to Surface Connections (BS)	16
15	Steel to Rod / Stud Connections (SR)	16
16	How to Order Exothermic Welding Powder & Accessories	17
17	Troubleshooting Guide	18

WHAT IS EXOTHERMIC WELDING

Exothermic welding, also known as exothermic bonding and is a welding process for joining two electrical conductors, that employs superheated copper alloy to permanently join the conductors. The process employs an exothermic reaction of a copper thermite composition to heat the copper, and requires no external source of heat or current. The chemical reaction that produces the heat is an aluminothermic reaction between aluminum powder and a metal oxide.

The reaction reaches very high temperatures, depending on the metal oxide used. The reactants are usually supplied in the form of powders, with the reaction triggered using a spark from a flint lighter. The activation energy for this reaction is very high however, and initiation requires either the use of a “booster” material such as powdered magnesium metal or a very hot flame source. The aluminum oxide slag that it produces is discarded.

When welding copper conductors, the process employs a semi-permanent graphite crucible mould, in which the molten copper, produced by the reaction, flows through the mould and over and around the conductors to be welded, forming an electrically conductive weld between them. When the copper cools, the mould is either broken off or left in place. Alternatively, hand-held graphite crucibles can be used. The advantages of these crucibles include portability, lower cost (because they can be reused), and flexibility, especially in field applications.

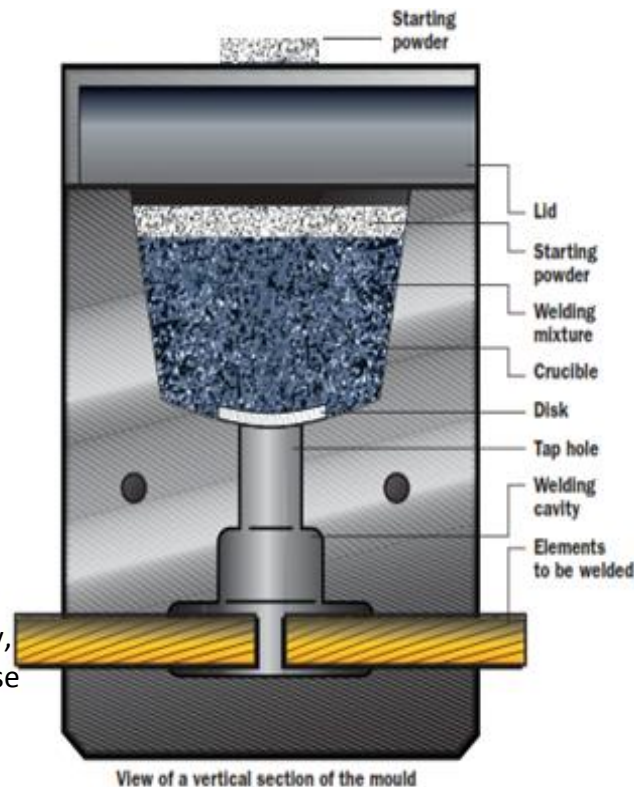

The weld formed has higher mechanical strength than other forms of weld, and excellent corrosion resistance. It is also highly stable when subject to repeated short-circuit pulses, and does not suffer from increased electrical resistance over the lifetime of the installation. However, the process is costly relative to other welding processes, requires a supply of replaceable mould, suffers from a lack of repeatability, and can be impeded by wet conditions or bad weather (when performed outdoors).

FEATURES

- It has a superior electrical conductivity than the conductors themselves.
- It does not corrode oxide or degrade with time and is resistant to galvanic coupling.
- It is able to withstand repeated electrical discharges.
- It never increases its resistance.
- It has higher mechanical and squeezing resistance than the conductors themselves.
- It offers a permanent welding and a low resistance connection, essential for achieving longwearing and trustworthy results in earthing.
- It guarantees the most common connections not only between copper cables but also for welding tapes and metallic pieces made of brass, stainless steel, and copper coated steel earth rods.

GENERAL & SAFETY INSTRUCTIONS:

- A. Only equipment and materials should be used to make connections.
- B. Do not connect items except as detailed in instruction sheets. Failure to comply with these instructions may result in improper and unsafe connections, damage to items being welded or even injury to body or property damage.
- C. Do not use worn or broken equipment which could cause leakage. Sealing compound should be used in case of fine leakages.
- D. When using Weld do not use welding material package if damaged or not fully intact.
- E. Make connections in conformance with instructions and all governing codes.
- F. Personnel should be properly trained and must wear safety glasses and gloves.
- G. Avoid contact with hot materials.
- H. Advise nearby personnel to stand at least 7 to 10 Foot away of welding operations site.
- I. Remove or protect the inflammable material from the operation site to safeguard against fire hazards.
- J. Provide adequate ventilation to the work area.
- K. Do not smoke when handling starting material.
- L. Avoid direct eye contact with “flash” of light from ignition of starting material.
- F. Welding material is an exothermic mixture and reacts to produce hot molten material with temperatures in excess of 1400°C (2500°F) and a localized release of smoke. Ignition temperatures are in excess of 900°C (1650°F) for welding material. **These materials are not explosive.**
- G. Adhering to the welding procedures will minimize risk of burns and fire caused by hot molten material spillage. In case of fire, use of water or CO₂ will aid in control of burning containers. Large quantities of water will aid in controlling a fire should the exothermic materials become involved. Water should be applied from a distance.
- H. All governing codes and regulations and those required by the job site must be observed. Always use appropriate safety equipment such as eye protection, hard hat, and gloves as appropriate to the application.

WARNING :

1. Products shall be installed and used only as indicated in product instruction sheets.
2. Products must never be used for a purpose other than the purpose for which they were designed or in a manner that exceeds specified load ratings.
3. All instructions must be completely followed to ensure proper and safe installation and performance.
4. Improper installation, misuse, misapplication or other failure to comply with instructions and warnings may cause bad weld joint, property damage or even serious badly injuries.

MAINTENANCE & STORAGE INSTRUCTIONS:

1. Mould is usually good for 50 - 60 connections in field conditions.
2. The equipment is fragile and should be handled carefully while in use.
3. Cleaning of mould should be done using appropriate brush / tool after the mould is reasonably cool after a weld process. Avoid hot mould cleaning.
4. Cavity cleaning should be carefully done to avoid damages / chipping.
5. On completion of task, mould should be well cleaned from inside and from outside using soft cloth. It should be properly wrapped in Bubble Plastic Packing while storing it.
6. The mould and the weld powder should always be stored in cool & dry places.
7. All tools and accessories must be cleaned before storing to safe reuse.

TOOLS REQUIRED FOR EXOTHERMIC WELDING PROCESS

1) Graphite Mould

Graphite mould is made of high quality graphite suitable for high quality welding work and can be used for several times. The exothermic welding reaction takes place in a specially designed, semi-permanent graphite mould. The mould is designed and manufactured with a specific weld cavity and it is in this cavity that the molten metal is allowed to flow to all sections of the required connection creating the permanent connection.

The connection mould is designed to last for an average of 30 to 100 connections depending upon the amount of Powder used per Joint (More the Powder Consumption per Joint, less will be the Connection & vice versa) . This will also vary according to the care given the mould during use. We recommend not using Mould for more than 60 to 70 Connections because the Weld cavity Size increases after every joint, eventually making the Weld Cavity shape improper resulting in improper shape Joint.



2) Mould Handle Clamp (HCC/HCD)

These will fit 90% of all standard exothermic Mould.

Normally we recommend one Handle for every two mould



3) Steel Metal Disk

Steel discs are very important. The disc act as timing device to allow the welding powder to heat to proper temperature, the disc away allowing the molten copper to a point where it would weld metal to enter the weld gravity before ignition. One Metal is must for every shot



4) Exothermic Weld Powder

Exothermic Weld Powder is the most reliable and consistently-performing weld metal available with us. Quality validation steps are taken for every lot we produce. Upon final acceptance, our weld metal is specially packaged in moisture-resistant plastic tubes with special closure caps. Then the cartridges and required metal discs are packaged in moisture-resistant boxes. All sizes of weld metal are available.

Standards Size Packing available are – 25 Grams, 45 Grams, 90 Grams

115 Grams, 150 Grams, 200 Grams, 250 Grams, 250 Grams,

Our standard packing for welding powder is the following - Firstly welding powder is in the tube and starting powder / Ignite Powder is in tube at the bottom of welding powder as shown in diagram 1.2.



1.1

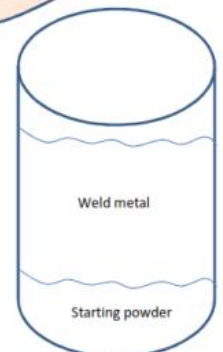

1.2

5) Ignite Powder (Starting Powder)

Ignite Powder also known as Starting Powder is required and is must. Pour little Starting Powder on the Mould followed by the Exothermic Weld powder and again pour little on the Top Side of Mould. Then, Ignite starting powder with a spark gun.

This resulting exothermic reaction reduces the weld powder to molten copper alloy. The molten copper alloy melts the retaining disc and flows into the weld cavity. Ignite Powder of 5 grams is sufficient for this Process.



6) Hand Gloves (HG)

Gloves is required for safety purpose as the Exothermic Weld Powder melts at more than 1400 degree Celsius. **One Hand Gloves Good for 250 Joints**



7) Flint Gun (FIG)

It is designed with the advantages of safety and convenience. It is used to ignite starting Powder in order to result in exothermic reaction.

We recommend one Flint Gun for every 80 Shots



8) Brush (Soft and Hard) (SHB)

Two Brush Required:

1) Soft Brush – Its used to Clean Mould Weld Cavity because its shape is very sensitive and cavity should not be any damage while using Brush, so we recommend to use Soft Brush to Clean Mould Weld Cavity

2) Hard Brush – Its used to clean other section of Mould

We recommend a Pair of Brush for 50 Connection



9) Slag Removal Tool (SRT)

It is used to remove the metal Scrap and Dust from the Mould.

We recommend one Slag Tool for 250 Connection



10) File Card (FCB)

It is used to clean the objects to be welded to remove rust and dirt

We recommend one Slag Tool for 100 Connection



11) Sealing Compound (SCD)

Sealing Compound is used to fill the gap on the mould where the conductor is passing.

We recommend one Packet of Sealing Compound for 100 Connection



12) Flame Torch (FT)

Sealing Compound is used to fill the gap on the mould where the conductor is passing.

We recommend one Flame Torch for 250 Joints



13) Safety Eye Glasses (SEG)

Safety Eye Glass should be wear to protect eyes.

We recommend one Glasses for 500 Joints



EXOTHERMIC WELD OPERATION PROCESS

The Exothermic Weld process is a method of making electrical connections of copper-to-copper or copper-to-steel in which no outside source of heat or power is required. In this process, conductors are prepared, placed in a purpose designed graphite mould, and exothermically welded to produce a permanent molecularly bonded electrical connection. The steps outlined below are a general demonstration of a typical welded connection. These basic steps are used for all electrical connections. Be sure to read and follow the instructions included with every Mould before making a connection.

STEP - 1:

Always wear protective safety glasses and gloves while working with exothermic welding products.

STEP - 2:

Gather all the proper material and equipment/accessories for the type of connection you are making. The typical Weld system requires all the Accessories as listed above on Page no. 04 and Page no. 05. Check to ensure the graphite Mould is not worn or broken, which could cause leakage of molten weld metal.



STEP - 3:

Slide the handle clamp into the pre-drilled holes with the proper orientation for the thumbscrews.

STEP - 4:

Tighten the clamp thumbscrews onto the mould.

STEP - 5:

Close the grips to tightly lock the Mould. Make adjustments to tighten/loosen the handle clamp.

STEP - 6:

The material to be welded (cable, rod, tape etc.) must be clean using the wire Brush and dry using the Flame Torch included in the set of accessories. Thus the oxide layer and superficial impurity is eliminated. Given that the graphite mould also absorbs moisture, this should be removed by preheating with a gas welding torch again to avoid a porous welding.

P.N - After the first welding is done, it is not necessary to re-heat the mould if the next welding is done within 15 minutes as it conserves the previously generated heat.

STEP - 7:

Place the conductors in the mould and close the handle clamps to avoid material leakages during the reaction.

Please Note – Always apply Sealing Compound at the places where the conductors is passing from the mould else at the time of Welding, the Exothermic Liquid will spread out as a flame resulting in improper joint

STEP - 8:

Place the metallic disk inside the mould and ensure that Powder should not enter into Weld Cavity.

STEP - 9:

Pour Exothermic Weld Powder into Graphite Mould. (Pour the Powder recommended and supplied by us)

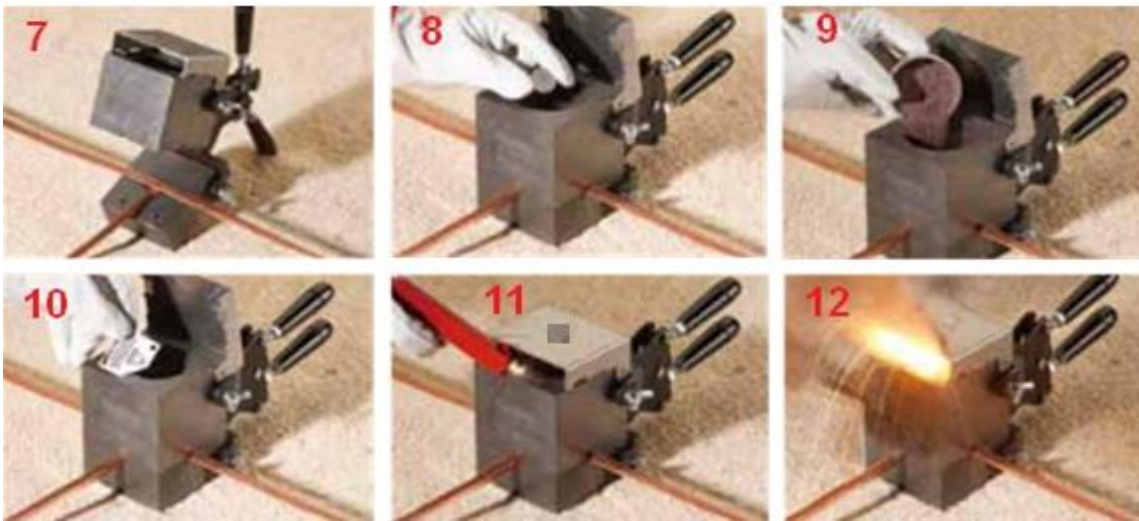

STEP - 10: Empty 50% of the starting powder above Exothermic Weld Powder (**Don't Mix, just scatter**) and then Close the Mould Mouth and then the rest 50% Starting Powder, sprinkle it on the Mould Mouth nearby the small hole given on the top of the Mould Mouth.

STEP - 11: Ignite the starting powder extended on the top/side of the mould using the flint igniters.

STEP - 12: Once started, the reaction will take 8-20 seconds during which it is recommended to stand clear of the mould.

STEP - 13:

After at least 3 minutes of the Mould cooling down, open the mould by undoing the handle grip. Remove the mould from the joint and clean the joint by removing slag with help of Slag Removal Tool and hard brush. Then clean the weld cavity with soft brush gently. The mould will be ready now to use again without having to reheat it as it is already warm.





































Note:



































In Normal case minimum two mould should be used on site to keep the process continue while one mould is cooled and cleaned after firing, the other should be used. The task should be undertaken very peacefully and one should not hurry.

Mould Selection Chart

































01) Cable to Cable Connections (CC)

CC - 1 	CC - 2 	CC - 3 	CC - 4 	CC - 5 
CC - 6 	CC - 7 	CC - 8 	CC - 11 	CC - 13 
CTC - 14 	CC - 17 	CC - 18 	CC - 19 	CC - 20 
CC - 21 	CC - 22 	CC - 23 	CC - 24 	CC - 25 
CC - 26 	CC - 27 	CC - 28 	CC - 29 	CC - 30 
CC - 33 	CC - 34 	CC - 35 	CC - 36 	CC - 37 
CC - 38 	CCC - 39 	CC - 40 	CC - 41 	















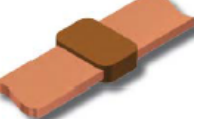

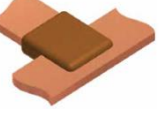
02) Cable to Ground Rod Connections (CR)

CR - 1 	CR - 2 	CR - 3 	CR - 4 	CR - 5 
CR - 6 	CR - 7 	CR - 8 	CR - 9 	CR - 10 
CR - 11 	CR - 12 	CR - 13 	CR - 15 	CR - 16 
CR - 17 	CR - 18 	CR - 19 	CR - 20 	CR - 21 
CR - 22 	CR - 23 	CR - 24 	CR - 26 	CR - 30 
CR - 33 	CR - 34 	CR - 35 	CR - 36 	CR - 37 
CR - 38 	CR - 39 	CR - 40 	CR - 41 	



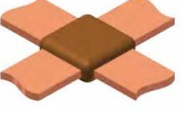
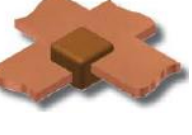











04) Cable to Bar (Copper Tape / Strip) or Cable Lugs Connection (CB)

CB - 1 	CB - 2 	CB - 3 	CB - 4 	CB - 5 
CB - 8 	CB - 9 	CB - 11 	CB - 12 	CB - 13 
CB - 14 	CB - 15 	CB - 16 	CB - 17 	CB - 18 
CB - 19 	CB - 20 	CB - 21 	CB - 22 	CB - 23 
CB - 24 	CB - 25 	CB - 26 	CB - 27 	CB - 28 
CB - 29 	CB - 30 	CB - 31 	CB - 32 	CB - 33 
CB - 34 	CB - 35 	CB - 36 	CB - 37 	CB - 38 



















04) Bar to Bar / Copper Tape to Tape (BB)

BB - 1 	BB - 2 	BB - 3 	BB - 4 	BB - 6 
BB - 7 	BB - 12 	BB - 14 	BB - 17 	BB - 20 
BB - 21 	BB - 22 	BB - 27 	BB - 33 	BB - 40 
BB - 41 	BB - 42 	BB - 43 	BB - 50 	











05) Re-Bar Connection (CRE)

CREC - 1 	CRE - 2 	CRE - 3 	CRE - 4 	CRE - 5 
CRE - 6 	CRE - 19 	CRE - 20 	BRE - 3 	BRE - 8 
BRE - 16 	BRE - 20 	RERE - 3 	RERE - 4 	RERE - 5 











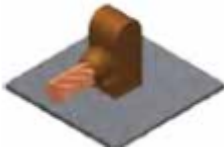





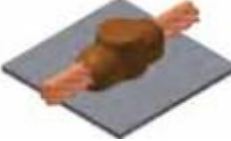
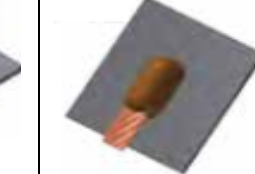

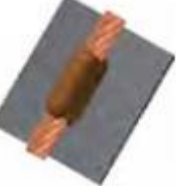





06) Ground Rod to Bar / Tape Connections (BR)

BR - 1 	BR - 2 	BR - 3 	BR - 4 	BR - 5 
BR - 6 	BR - 7 	BR - 8 	BR - 9 	BR - 11 
BR - 12 	BR - 13 	BR - 14 	BR - 15 	BR - 16 
BR - 17 	BR - 18 	BR - 19 	BR - 25 	

07) Ground Rod to Ground Rod Connections (RR)

RR - 1 	RR - 2 	RR - 3 	RR - 4 	RR - 5 
RR - 6 	RR - 7 	RR - 13 	RR - 14 	RR - 15 
RR - 16 				

08) Cable to Surface (Steel/Copper) Connections (CS)

CS - 1 	CS - 2 	CS - 3 	CS - 4 	CS - 6 
CS - 7 	CS - 8 	CS - 9 	CS - 12 	CS - 13 
CS - 14 	CS - 15 	CS - 16 	CS - 22 	CS - 23 
CS - 24 	CS - 25 	CS - 26 	CS - 27 	CS - 31 
CS - 32 	CS - 34 	CS - 36 	CS - 38 	CS - 48 
CS - 50 	CS - 52 			

09) Bar to Surface Connections (BS)

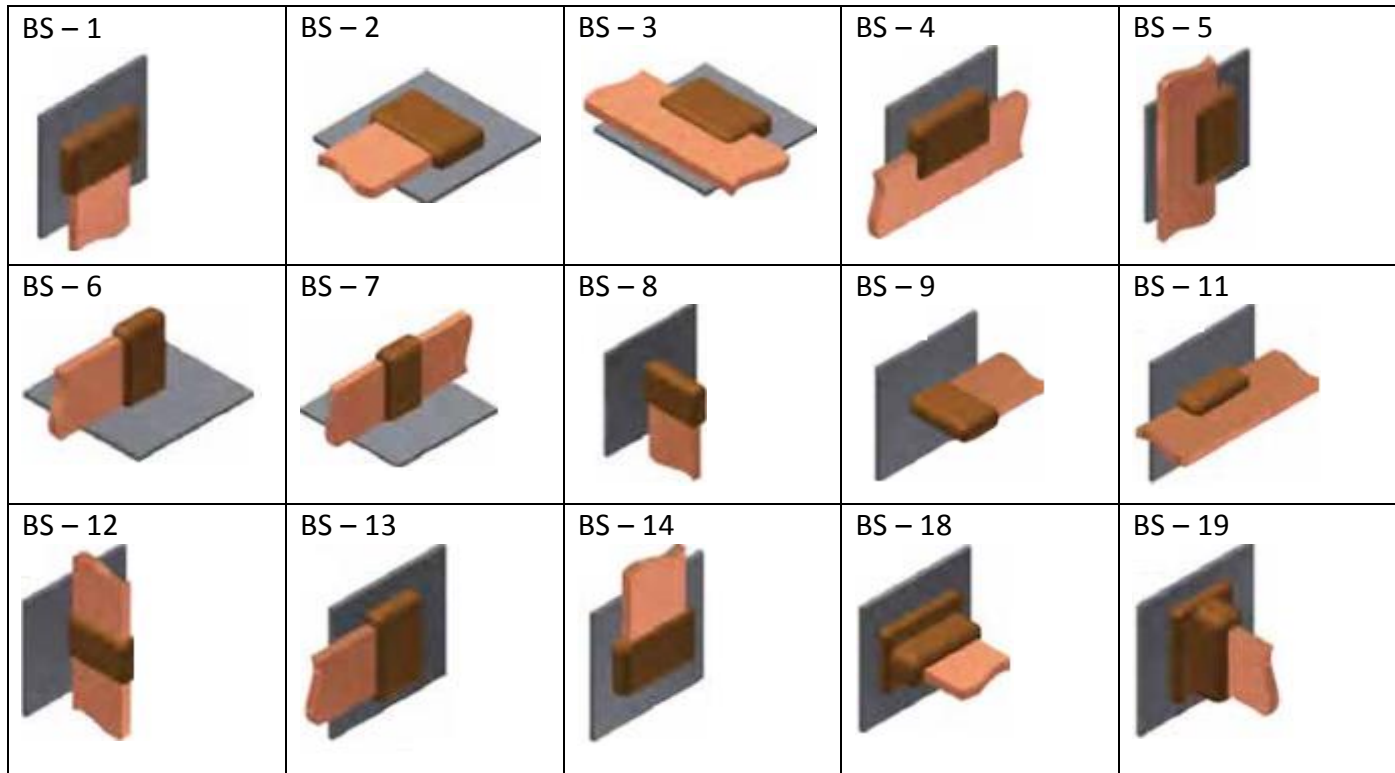

10) Steel to Rod / Stud Connections (SR)

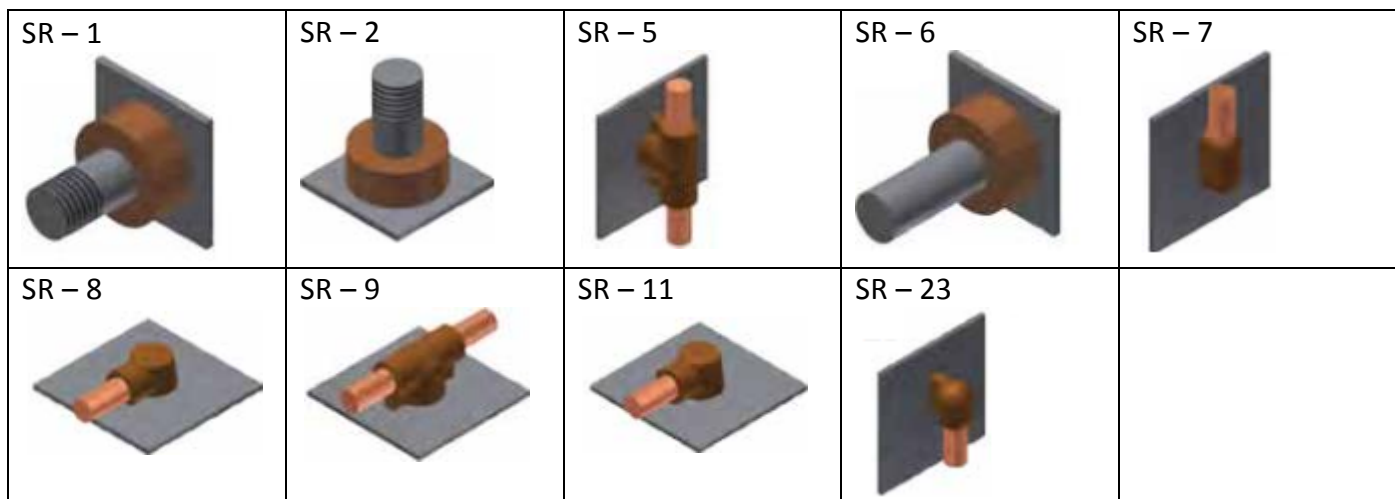

P.N – There are more than thousands of Design for Different Size and Different Shape. In case if none of your design is appearing here than please drop a mail at info@exothermicweld.com and we will design as per your requirement.

Please refer our website www.exothermicweld.com to find out more different types of Joints

How to Order / Know your Exothermic Welding Joint

The most common exothermic connections are listed in this product catalogue for your easy reference. However, it would not be feasible to place all the possible connections, configurations and sizes of conductor in this catalogue as the amount is simply too vast and is constantly growing.

With a database of more than 20,000 moulds Design we cannot design the Moulds and keep in stock as the design is not common everywhere and the size of Conductor / Strip also change. If you do not see the connection you require, configuration or size of conductor required by you mentioned in this product catalogue then please contact us at info@exothermicweld.com or info@amiableimpex.com with the below relevant information and we will advise you accordingly.

Now, please refer the below Sketch and we recommend our customers to provide the same as below in order to avoid misinterpretation and miscommunication:

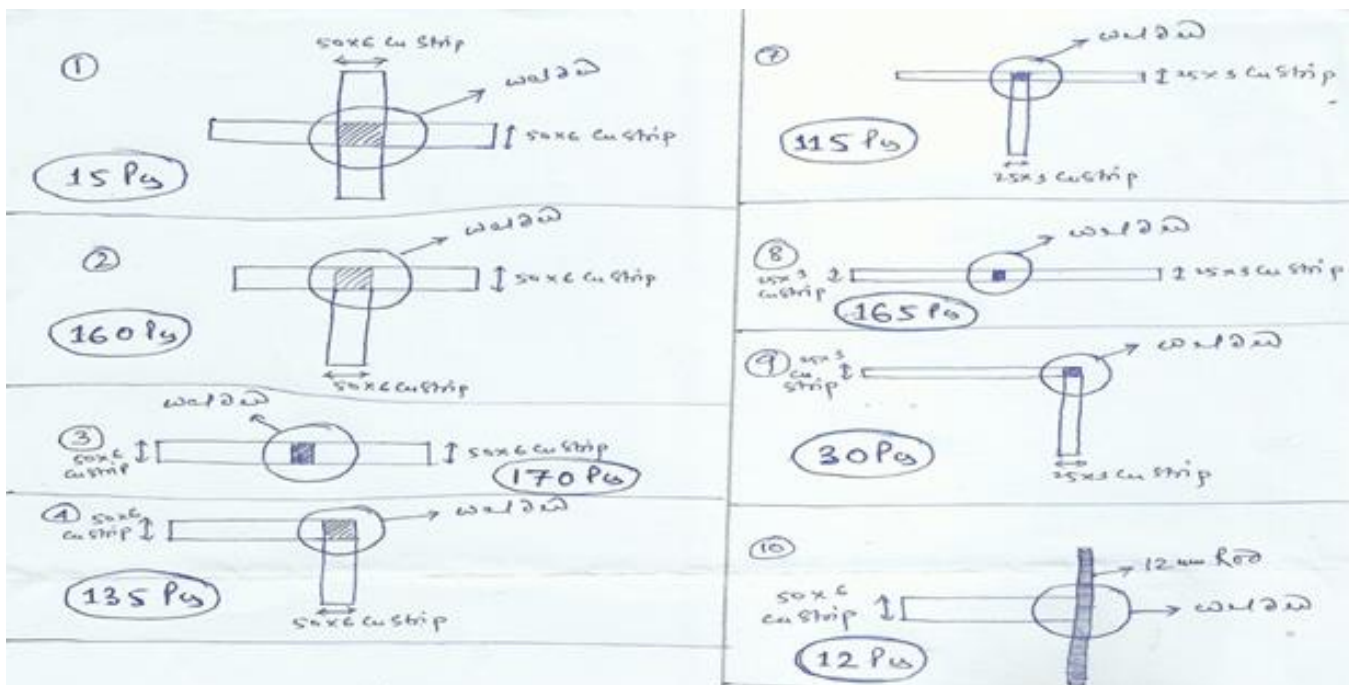

Now in order to make the sketch you need to:

1. Know the materials to be welded (Copper Conductor, Copper Strips, Steel Plate, Rod etc.)
2. Determine the weld type using the selector charts given above.

The Common Joints are:

- i) Straight Joint, T Joint, Cross Joint (Overlap) & L Joint

So, Find the required weld type and determine the material sizes and types (mm, mm², stranded, solid etc.)

5. Total Number of Joints required

Once we get the above information / Sketch, we will submit the quotation and will recommend:

- i) The Proposed Quantity for Mould
- ii) The Propose Quantity of Powder require per Joint (With / Without Provision)
- iii) The Propose quantity of Accessories require per Joint (i.e. Mould Handle, Flint Gun, Brushes, Gloves etc.)

Trouble Shooting Guide

Problem	Probable Cause	Correction To Make
Insufficient metal to make weld.	Leaking of Exothermic liquid from the Graphite Mould near Cavity side.	Replace mould or if only worn around conductor opening, use Sealing Compound around conductor where conductor passes from Mould.
	Use of wrong size Exothermic Powder cartridge for mould.	Please check the Mould / Mould Box / Quotation File and tally the amount of Powder require per Joint. Every Tube consisting of different grams Exothermic Powder has different chemical composition.
	Too much spillage of Exothermic powder while pouring in Graphite Mould.	Carefully open the Exothermic Powder Tube and ensure that the Powder to be poured in the Graphite Mould only without any Spillage.
	Wrong mould for conductor being used.	i) Replace with correct mould if have. ii) If Conductor not going Smoothly than use Glass Paper and rub gently at Weld Cavity ensuring equal rubbing on both side of Cavity. iii) If Conductor goes very easily and Liquid Pouring out of Mould even after using of Sealing Compound than use Copper Foil and ensure the Conductor and Hole gap not more than 0.3mm
Mould does not close tightly causing weld metal to leak out.	Handle clamps not properly adjusted.	Remove set screw between the handles of the mould and adjust handle tension by backing out the eye bolt.
	Dirt or Slag stuck in the edge of the Mould or near the Weld Cavity	Clean mould thoroughly between connections.
	Bent or out-of-round cable.	Straighten or cut out bad section of cable.
Handle clamps will not lock or closed.	Handle clamps not properly adjusted.	Remove set screw between the handles of the mould and adjust handle tension by backing out the eye bolt.
Excessively high weld, bubbly or gassy appearance, poor weld.	Moisture in mould.	Pre-heat mould to above 220° F with a propane torch.
	Oil, grease, moisture or foreign material on conductors.	Pre-heat conductors with propane torch then use a clean wire brush on conductor to remove any residue left on conductors. If welding to cast iron or steel surface, weld area must be cleaned down to with wire brush to remove rust
	Use of wrong size Exothermic Powder cartridge for mould.	Please check the Mould / Mould Box / Quotation File and tally the amount of Powder require per Joint.
	Sealing Compound Appearance in side weld Cavity	Take special precautions to keep duct seal out of weld cavity.
	Weld powder caught moisture	Replace with fresh, dry weld powder.
Exothermic Weld Powder spills from the Mould near Cavity	Mould worn or disc is cracked allowing powder to leak into mould cavity.	Replace mould.
	Forgot to use steel disc or did not seat it properly at bottom of crucible.	Make sure disc is seated at bottom of crucible before pouring the powder into crucible.

Trouble Shooting Guide continuation.....

Problem	Probable Cause	Correction To Make
Cannot ignite powder.	Insufficient starting powder pours in the Mould or at the top of Mould	Place at least half of the Starting Powder from the Lock Bag provided in bottom of Exo Powder Tube.
	Flint ignitor shooting not giving enough spark.	Replace flint ignitor. P.N – Flint Gun gives average 80 Sparks only.
Mould wearing out too fast. (Not Making enough Joint recommended by us)	Improper cleaning of mould.	Use mould cleaner brush provided. P.N – Use Soft Brush to clean Weld Cavity Hard Brush to Clean Mould Crucible Don't Use Wire Brush for Cleaning Moulds
	Bent or out of round cable causes damage and premature wear of the mould.	Be caution when closing mould. Does not force mould to shut around bent, twisted or out of round conductors
Poor weld to ground rod.	Exothermic Liquid spilling out from the Bottom where Rod is Placed Vertically	Use more Sealing Compound at the Bottom where the Rod is Placed and ensure that Exothermic Liquid not Spilling. In case if spilling again than Use Copper Foil and Cover with Rod and ensure Graphite Mould have tight grip to
	Moisture or Rust on cable or ground rod.	Pre-heat conductors with propane torch then use a clean wire brush on conductors and Rod to remove any residue / rust / dirt left on conductors.
Weld not sticking to Steel Surface	Improperly cleaned area on steel.	Clean the Steel Surface properly with Wire Brush and ensure no rust and dirt on the Surface.
	Moisture or contaminant on cable or steel surface.	Pre-heat conductors with propane torch then use a clean wire brush on conductors to remove any residue left on conductors.
	Cable is improperly positioned in mould, blocking the flow of weld metal.	Position cable in mould in accordance with directions for mould. If directions are not available, position top of cable in the centre of where the liquid weld metal hits the steel.
Cable pulls out of mould when it is fired.	Cables are either twisted or under tension.	Use our recommended cable clamp or other method to remove tension. Cut out severely twisted cable.

**India Regd. Office -****AMIABLE IMPEX**

101-A, Surya Darshan, Pai Nagar, J.S Road, Borivali(W), Mumbai – 400092. India.

Phone: +91-9594899995 / +91-22-28933996,

E-mail: info@exothermicweld.com

Dubai Office –**PURE PEARLS TRADING LLC.**

Office number 202, 2ndFloor, Al - Jawhra Building,

Behind Deira Palace Hotel, Mushid Bazaar Deira Dubai – UAE.

Email id – info@exothermicweld.com / krupal@amiableimpex.com

Admin. Office -**AMIABLE IMPEX**

501-A, Surya Darshan, Pai Nagar, J.S Road, Borivali(W), Mumbai – 400092. India.

Phone: +91-9594899995 / +91-22-28933996,

E-mail: maulik@amiableimpex.com

Contact Person - MAULIK SHAH

E-mail: info@exothermicweld.com

Mob: +91-959-489-9995 / +91-22-2893-3996

**Website: www.exothermicweld.com
www.amiableimpex.com**